

OSRAM
 Opto Semiconductors

OSRAM Opto Semiconductors, Inc.

SFH 7710

Nambari ya Sehemu:

SFH 7710

Mtengenezaji / Brand:

OSRAM Opto Semiconductors, Inc.

Maelezo ya bidhaa

SENSOR TILT DIGITAL 10MA SMD

Datasheets:

 SFH 7710.pdf

Hali ya RoHS

 Kuongoza bure / RoHS Inavyotakiwa

Meli Kutoka

Hong Kong

Njia ya Uhamisho

DHL/Fedex/TNT/UPS/EMS

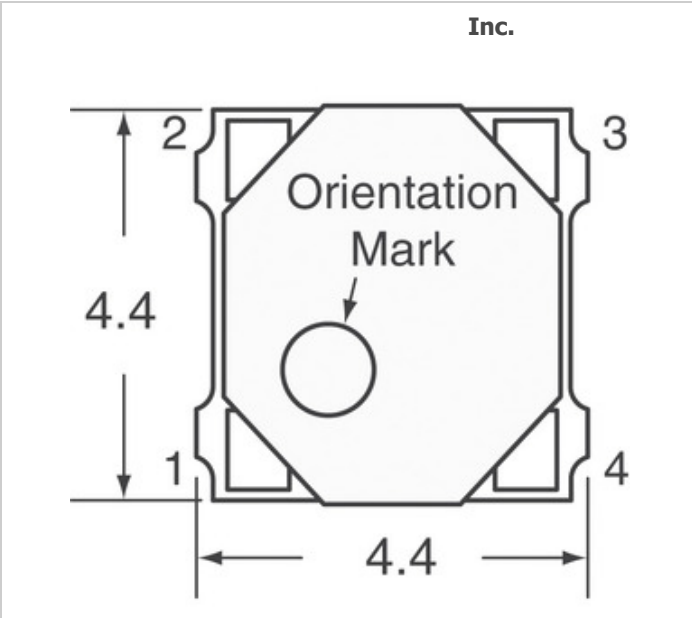

Picha inaweza kuwa uwakilishi. Angalia maelezo ya maelezo ya bidhaa.

[OMBI LA NUKUU](#)











Ufafanuzi wa SFH 7710

NAMBARI YA SEHEMU	SFH 7710
MTENGENEZAJI	OSRAM Opto Semiconductors, Inc.
MAELEZO	SENSOR TILT DIGITAL 10MA SMD
HALI YA BURE YA BURE / HALI YA ROHS	Kuongoza bure / RoHS Inavyotakiwa
KARATASI YA DATA	 SFH 7710.pdf
UGAVI WA VOLTAGE	2.3 V ~ 3.6 V
MFULULIZO	-
UFUNGAJI	Tape & Reel (TR)
PAKET / UCHUNGUZI	4-SMD
AINA YA PATO	Digital, Open Drain
MAJINA MENGINE	475-1269-2 Q3437777 Q65110A4407 SFH 7710-Z
JOTO LA UENDESHAJI	-20°C ~ 65°C
ANGLE YA UENDESHAJI	-
AINA YA KUINUA	Surface Mount
KIWANGO CHA SENSITIVITY MOISTURE (MSL)	4 (72 Hours)
HALI YA BURE YA BURE / HALI YA ROHS	Lead free / RoHS Compliant
SASA - PATO	10mA

Tags kuhusiana

OSRAM Opto Semiconductors, Inc. SFH 7710	Msambazaji wa SFH 7710	Mtoaaji wa SFH 7710
Bei ya SFH 7710	Picha za SFH 7710	Picha ya SFH 7710
Datasheet ya PDF ya SFH 7710	Datasheet ya kupakua SFH 7710	Datasheet ya SFH 7710
SFH 7710 Hisa	Nunua SFH 7710	Nunua OSRAM Opto Semiconductors, Inc. SFH 7710
OSRAM Opto Semiconductors, Inc. SFH 7710	Mtoaaji wa OSRAM Opto Semiconductors, Inc.	Msambazaji wa OSRAM Opto Semiconductors, Inc.
OSRAM Opto Semiconductors, Inc. SFH 7710	OSRAM Opto Semiconductors Inc. SFH 7710	

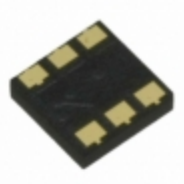
Bidhaa zinazohusiana

 <p>SFH 7225-Z Wazalishaji: OSRAM Opto Semiconductors, Inc. Maelezo: LED YELLOW CLEAR SMD Katika hisa: Out stock</p> <p>RFQ</p>	 <p>SFH 7251 Wazalishaji: OSRAM Opto Semiconductors, Inc. Maelezo: EMITTER IR MULTI TOPLED Katika hisa: Out stock</p> <p>RFQ</p>
 <p>SFH 757 Wazalishaji: International Rectifier (Infineon Technologies) Maelezo: TRANSMITTER DIODE FIBER OPTIC Katika hisa: Out stock</p> <p>RFQ</p>	 <p>SFH 7250 Wazalishaji: OSRAM Opto Semiconductors, Inc. Maelezo: EMITTER IR 850NM Katika hisa: Out stock</p> <p>RFQ</p>
 <p>SFH 7771 Wazalishaji: OSRAM Opto Semiconductors, Inc. Maelezo: CHIP ON BOARD Katika hisa: Out stock</p> <p>RFQ</p>	 <p>SFH 7770 E6 Wazalishaji: OSRAM Opto Semiconductors, Inc. Maelezo: ALS, PROXIMITY SENSOR (2-IN-1) Katika hisa: Out stock</p> <p>RFQ</p>
 <p>SFH 7252 Wazalishaji: OSRAM Opto Semiconductors, Inc. Maelezo: MULTI TOPLED Katika hisa: Out stock</p> <p>RFQ</p>	 <p>SFH 7741-Z Wazalishaji: OSRAM Opto Semiconductors, Inc. Maelezo: PROXIMITY SENSOR 30MM Katika hisa: Out stock</p> <p>RFQ</p>
 <p>SFH 7740-Z Wazalishaji: OSRAM Opto Semiconductors, Inc. Maelezo: SENSOR OPTO REFLECTIVE 6SMD Katika hisa: Out stock</p> <p>RFQ</p>	 <p>SFH 757V Wazalishaji: International Rectifier (Infineon Technologies) Maelezo: TRANSMITTER DIODE FIBER OPTIC Katika hisa: Out stock</p> <p>RFQ</p>
 <p>SFH 7743-Z Wazalishaji: OSRAM Opto Semiconductors, Inc. Maelezo: PHOTODETECTOR SCHMITT SMD Katika hisa: Out stock</p> <p>RFQ</p>	 <p>SFH 7770 Wazalishaji: OSRAM Opto Semiconductors, Inc. Maelezo: LIGHT SENSOR AMBIENT SMD Katika hisa: Out stock</p> <p>RFQ</p>

Hati miliki © 2020 Msambazaji wa kuamika wa Vipengele vya Elektroniki - Ocean-Components.com

E-mail: Info@Ocean-Components.com

Anwani: Room 2102, Connaught Commercial Building, 185 Wan Chai Rd, Wan Chai, Hong Kong

