



Grayhill, Inc.

## 62S11-M5-020CH

Nambari ya Sehemu:

62S11-M5-020CH

Mtengenezaji / Brand:

Grayhill, Inc.

Maelezo ya bidhaa

ROTARY ENCODER OPTICAL 32PPR

Datasheets:

 62S11-M5-020CH.pdf

Hali ya RoHs

 Kuongoza bure / RoHS Inavyotakiwa

Meli Kutoka

Hong Kong

Njia ya Uhamisho

DHL/Fedex/TNT/UPS/EMS

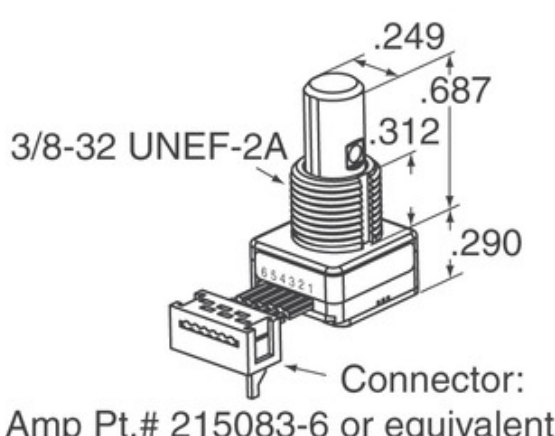

Picha inaweza kuwa uwakilishi. Angalia maelezo ya maelezo ya bidhaa.









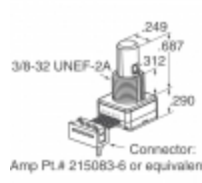

### Ufafanuzi wa 62S11-M5-020CH

NAMBARI YA SEHEMU	62S11-M5-020CH
MTENGENEZAJI	Grayhill, Inc.
MAELEZO	ROTARY ENCODER OPTICAL 32PPR
HALI YA BURE YA BURE / HALI YA ROHS	Kuongoza bure / RoHS Inavyotakiwa
KARATASI YA DATA	 62S11-M5-020CH.pdf
UGAVI WA VOLTAGE	5V
SINEMA YA KUKOMESHA	Cable with Connector
MFULULIZO	62S
MAISHA YA MZUNGUKO (MIZUNGUKO MIN)	1M
PULSES KWA MAPINDUZI	32
AINA YA PATO	Quadrature (Incremental)
MAJINA MENGINE	62S11M5020CH
MWELEKEO	Vertical
AINA YA KUINUA	Panel Mount
KIWANGO CHA SENSITIVITY MOISTURE (MSL)	1 (Unlimited)
MTENGENEZAJI WA MUDA WA KIWANGO KIWANGO	8 Weeks
HALI YA BURE YA BURE / HALI YA ROHS	Lead free / RoHS Compliant
AINA YA ENCODER	Optical
UZOEFU	Yes
IMEJENGWA KATIKA KUBADILI	Yes
AINA YA ACTUATOR	1/4" Dia Flatted End

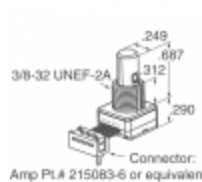
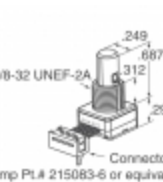
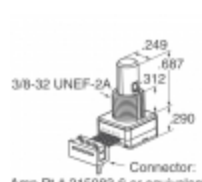
### Tags kuhusiana

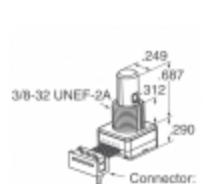
Grayhill, Inc. 62S11-M5-020CH	Msambazaji wa 62S11-M5-020CH	Mtoaji wa 62S11-M5-020CH
Bei ya 62S11-M5-020CH	Picha za 62S11-M5-020CH	Picha ya 62S11-M5-020CH
Datasheet ya PDF ya 62S11-M5-020CH	Datasheet ya kupakua 62S11-M5-020CH	Datasheet ya 62S11-M5-020CH
62S11-M5-020CH Hisa	Nunua 62S11-M5-020CH	Nunua Grayhill, Inc. 62S11-M5-020CH
Grayhill, Inc. 62S11-M5-020CH	Mtoaji wa Grayhill, Inc.	Msambazaji wa Grayhill, Inc.
Grayhill, Inc. 62S11-M5-020CH	Grayhill Inc. 62S11-M5-020CH	

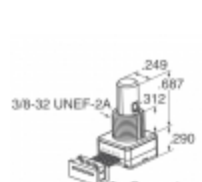
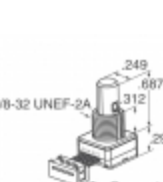
### Bidhaa zinazohusiana

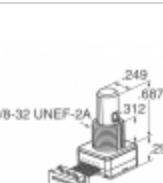
 <p><b>62S11-M5-040C</b> Wazalishaji: Grayhill, Inc. Maelezo: ROTARY ENCODER OPTICAL 32PPR Katika hisa: Out stock</p> <p><b>RFQ</b></p>	 <p><b>62S11-M5-020C</b> Wazalishaji: Grayhill, Inc. Maelezo: ROTARY ENCODER OPT 32PPR 2" CBL Katika hisa: Out stock</p> <p><b>RFQ</b></p>
 <p><b>62S11-M0-PV</b> Wazalishaji: Grayhill, Inc. Maelezo: ROTARY ENCODER OPTICAL 32PPR Katika hisa: Out stock</p> <p><b>RFQ</b></p>	 <p><b>62S11-M5-030CH</b> Wazalishaji: Grayhill, Inc. Maelezo: ROTARY ENCODER OPTICAL 32PPR Katika hisa: Out stock</p> <p><b>RFQ</b></p>
 <p><b>62S11-M0-200S</b> Wazalishaji: Grayhill, Inc. Maelezo: ROTARY ENCODER OPTICAL 32PPR Katika hisa: Out stock</p> <p><b>RFQ</b></p>	 <p><b>62S11-M5-050C</b> Wazalishaji: Grayhill, Inc. Maelezo: ROTARY ENCODER OPT 32PPR 5" CBL Katika hisa: 558 pcs</p> <p><b>RFQ</b></p>
 <p><b>62S11-M5-030C</b> Wazalishaji: Grayhill, Inc. Maelezo: ROTARY ENCODER OPTICAL 32PPR Katika hisa: Out stock</p> <p><b>RFQ</b></p>	 <p><b>62S11-M0-210SH</b> Wazalishaji: Grayhill, Inc. Maelezo: ROTARY ENCODER OPT 32PPR 20" CBL Katika hisa: Out stock</p> <p><b>RFQ</b></p>
 <p><b>62S11-M5-020S</b> Wazalishaji: Grayhill, Inc. Maelezo: ROTARY ENCODER OPTICAL 32PPR Katika hisa: Out stock</p> <p><b>RFQ</b></p>	 <p><b>62S11-M5-020SH</b> Wazalishaji: Grayhill, Inc. Maelezo: ROTARY ENCODER OPT 32PPR 2" CBL Katika hisa: Out stock</p> <p><b>RFQ</b></p>
 <p><b>62S11-M0-P</b> Wazalishaji: Grayhill, Inc. Maelezo: ROTARY ENCODER OPTICAL 32PPR Katika hisa: Out stock</p> <p><b>RFQ</b></p>	 <p><b>62S11-M0-PH</b> Wazalishaji: Grayhill, Inc. Maelezo: ROTARY ENCODER OPTICAL 32PPR Katika hisa: Out stock</p> <p><b>RFQ</b></p>

Hati miliki © 2020 Msambazaji wa kuaminika wa Vipengele vya Elektroniki - Ocean-Components.com

E-mail: [Info@Ocean-Components.com](mailto:Info@Ocean-Components.com)

Anwani: Room 2102, Connaught Commercial Building, 185 Wan Chai Rd, Wan Chai, Hong Kong

